



ET Series

Model ETB  
ETPB

# Operating Instructions

Valid as of: 01.10.2010 • Please keep the manual for future reference!

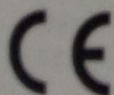

# Contents

<b>1</b>	<b>Warranty and Liability</b>	<b>3</b>
1.1	Notices within the Operating Instructions	3
1.2	Responsibilities of the Operating Company	3
1.3	Responsibilities of the Personnel	3
1.4	Informal Safety Measures	4
1.5	Training of the Personnel	4
1.6	Intended Use	4
1.7	Dangers in Handling the Device	4
1.8	Copyright	4
1.9	Declaration of Conformity, RoHs II and WEEE Registration	4
<b>2</b>	<b>Available Models</b>	<b>5</b>
2.1	Specifications	5
2.2	Delivery Includes	6
2.3	Unpacking	6
<b>3</b>	<b>Initial Setup and Operating Procedure</b>	<b>6</b>
3.1	Notes Before Starting Measurement	6
3.1.1	ID Plate, CE Mark, Calibration Label	6
3.1.2	Removing the Filament Guide	7
3.1.3	Mounting the Filament Guide	7
3.2	Operating Elements	8
3.3	Setup	8
3.3.1	Charging the Battery	8
3.3.2	Switch-On	9
3.3.3	Switch-Off	9
3.3.4	Reversing the Display	9
3.3.5	Selecting the Unit of Measure	9
3.3.6	Zero Adjustment of the Measuring Position (Auto Zero)	10
3.4	Operating Procedure	10
3.4.1	Switching on Damping Mode	11
3.4.2	Changing the Damping Factor	11
3.5	Storing the Tension Values	12
3.5.1	Recalling the Stored Tension Values	12
3.5.2	Clearing the ETB Memory	13
3.5.3	Memory Function HOLD	13
3.6	Error Messages	13
3.7	Static Verification of Measuring Accuracy	14
3.8	Dynamic Calibration of the ETB	15
3.9	Static Calibration of the ETB	15
3.9.1	Restoring the Factory Calibration	18
<b>4</b>	<b>Service and Maintenance</b>	<b>18</b>
4.1	Rollers	18
4.2	Replacing the Rollers/Ceramic Pins	19
<b>5</b>	<b>Verification of Calibration and Determination of Repair Costs</b>	<b>22</b>
<b>6</b>	<b>Cleaning</b>	<b>23</b>
<b>7</b>	<b>Correspondence</b>	<b>23</b>
<b>8</b>	<b>Repairs</b>	<b>23</b>

## 1 Warranty and Liability

In principle, the supply of the device is subject to our "General Conditions of Sale and Delivery." These have been provided to the operating company on conclusion of the contract, at the latest.

Warranty:

- SCHMIDT tension meters are warranted for 12 months.

Parts subject to wear, electronic components and measuring springs are not covered by the warranty. No warranty or liability will be accepted for bodily injury or property damage resulting from one or several of the following causes:

- Misuse or abuse of the device.
- Improper mounting, commissioning, operation and maintenance of the device (e.g. verification interval).
- Operation of the device if any safeguards are defective or if any safety and protection precautions are not properly installed or not operative.
- Failure to comply with the notices in the Operating Instructions regarding transport, storage, mounting, commissioning, operation, maintenance and setup of the device.
- Any unauthorized structural alteration of the device.
- Insufficient inspection of device components that are subject to wear.
- Opening the device or improper repair work.
- Disasters caused by the effects of foreign objects or by force majeure.

### 1.1 Notices within the Operating Instructions

The fundamental prerequisite for the safe handling of this device and its troublefree operation is the knowledge of the basic safety notices and safety instructions.

These Operating Instructions contain the most important notices for the safe operation of the device.

These Operating Instructions, in particular the safety notices, must be observed by any person who works with the device. In addition, the local valid rules and regulations for the prevention of accidents must be complied with.

The representations within the Operating Instructions are not true to scale.

The dimensions given are not binding.

General indications of direction, such as FRONT, REAR, RIGHT, LEFT apply when viewing the front of the device.

### 1.2 Responsibilities of the Operating Company

In compliance with the EC Directive 89/655/EEC, the operating company agrees to only permit persons to work with the device who:

- are familiar with the basic regulations on industrial safety and accident prevention and who have been trained in handling the device.
- have read and understood the chapter on safety and the warning notices in these Operating Instructions and have confirmed this with their signatures.
- are examined regularly on their safe and conscientious working method.

### 1.3 Responsibilities of the Personnel

All persons who work with the device agree to perform the following duties before starting work:

- to observe the basic regulations on industrial safety and accident prevention.
- to read the chapter on safety and the warning notices in these Operating Instructions and to confirm with their signatures that they have understood them.

#### 1.4 Informal Safety Measures

The Operating Instructions must always be kept on hand where the device is operated. Apart from the Operating Instructions, the general and local valid regulations on accident prevention and environmental protection must be provided and complied with.

#### 1.5 Training of the Personnel

Only trained and instructed personnel is permitted to work with the device. The responsibilities of the personnel must be clearly defined for mounting, commissioning, operation, setup, maintenance, and repair. Trainees may only work with the device under the supervision of experienced personnel.

#### 1.6 Intended Use

The device is intended exclusively to be used as a tension meter. Any other use or any use exceeding this intention will be regarded as misuse. Under no circumstances shall HANS SCHMIDT & Co GmbH be held liable for damage resulting from misuse.

The intended use also includes:

- Complying with all notices included in the Operating Instructions and observing all inspection and maintenance works.

#### 1.7 Dangers in Handling the Device

The device was designed according to the state of the art and the approved safety standards. Nevertheless, its use may cause serious or fatal injury to the user or third persons, and/or an impairment of the device or of other material assets.

The device may only be applied:

- For its intended use in a faultless condition with regard to the safety requirements.
- Malfunctions that could impair safety must be remedied immediately.
- Personal protective equipment must be used according to the EC Directive 89/686/EEC.

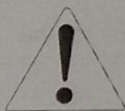

**The device must not be operated in potential explosive areas and must not come into contact with aggressive substances.**

#### 1.8 Copyright

The copyright on these Operating Instructions remains with the company HANS SCHMIDT & Co GmbH.

These Operating Instructions are intended for the operating company and its personnel only. They contain instructions and notices that may only be reproduced on the prior written permission of

HANS SCHMIDT & Co GmbH

and under indication of the complete reference data.

Violations will be prosecuted.

#### 1.9 Declaration of Conformity, RoHs II and WEEE Registration

In compliance with the EU Directives 2004/108/EG and 2011/65/EU



**HANS SCHMIDT & CO GmbH is registered in compliance with the German Electrical and Electronic Equipment Act (ElektroG) under WEEE Reg. No. DE 48092317.**

## 2 Available Models

1

The standard series is also available with the following modifications (customized versions): - Special calibration using customer supplied material.

Model	Tension Ranges cN	*Measuring Head Width mm	SCHMIDT Calibration with running filament
ETB-100	0.5 - 100.0	24	PA: 0.20 mm Ø
ETB-200	2 - 200	24	PA: 0.20 mm Ø
ETB-500	2 - 500	24	PA: 0.20 mm Ø
ETPB-100	0.5 - 100.0	24	PA: 0.20 mm Ø
ETPB-200	2 - 200	24	PA: 0.20 mm Ø
ETPB-500	2 - 500	24	PA: 0.20 mm Ø

\* Outer distance between outside guide rollers / pins

\*\* Suitable for 95% of all applications.

PA = Polyamide Monofilament.

If the material to be measured differs significantly from the SCHMIDT calibration material in diameter, rigidity, shape, etc., we recommend calibration using customer supplied material.

For this purpose, a material sample of about 5 m should be supplied.

International unit of tensile force: 1 cN = 1.02 g = 0.01 N

ETB: Calibration with approx. 100 m/min

ETPB: Calibration with approx. 60 m/min

### 2.1 Specifications

<b>Calibration:</b>	According to SCHMIDT factory procedure
<b>Units of Measure:</b>	cN / g, user selectable
<b>Accuracy:</b>	± 1% FS* ± 1 digit (typical ± 0.5% FS*)
<b>Overrange:</b>	10% FS*, without accuracy guarantee
<b>Overload Protection</b>	200% FS*
<b>Measuring Principle:</b>	Strain gauge bridge
<b>Meas. Roller Deflection:</b>	0.5 mm, max.
<b>Signal Processing:</b>	Digital, 24 bit A/D converter
<b>Damping:</b>	Adjustable electrical (averaging)
<b>Meas. Frequency:</b>	Approx. 1 kHz internal (MIN <sub>PEAK</sub> , MAX <sub>PEAK</sub> )
<b>Display Update Rate:</b>	2x per sec. (Last, AVR, MIN, MAX)
<b>Display:</b>	4-digit LCD, 11 mm high
<b>Memory:</b>	Average, last value, maximum, minimum, MAX <sub>PEAK</sub> , MIN <sub>PEAK</sub>
<b>Temperature coefficient:</b>	Gain: less than ± 0.01% FS*/°C
<b>Temperature Range:</b>	10 - 45° C
<b>Air Humidity:</b>	85% RH, max.
<b>Auto Power Off:</b>	Automatic after approx. 3 min. of non-use
<b>Power Supply:</b>	LiPo accumulator (60 h continuous use, 3 ½ charging time) and AC adapter 100 ... 240 V AC with country-specific adapters (EU/USA/UK)
<b>Housing Material:</b>	Aluminium profile with plastic outer casing (PVC)
<b>Housing Dimensions:</b>	197 mm x 58 mm x 47 mm (L x W x H)
<b>Weight (net / gross):</b>	Approx. 340 g / 1250 g

\*FS = Full Scale

## 2.1 Specifications (continued)

### ETB Guide Rollers:

V - grooved	Line Speed m/min max.	Roller Material
Standard	2000	Aluminium hard chromed

### ETPB Guide Pins:

V - grooved	Line Speed m/min max.	Pin Material
Standard	6000	Oxide ceramic

## 2.2 Delivery Includes

Tension meter

1 AC-adapter with 3 country-specific adapters (EU/USA/UK)

1 Open end wrench (4 mm jaw width)

1 Screwdriver (1.5 mm blade width)

1 Operating Instructions

1 Carrying case

## 2.3 Unpacking

Unpack the tension meter and inspect it for any shipping damage. Notices of defect must be filed immediately, at the latest within 10 days on receipt of the goods.

## 3 Initial Setup and Operating Procedure

### 3.1 Notes Before Starting Measurement

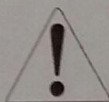

Have you read and understood the Operating Instructions, in particular Chapter 1 „Basic Safety Notices“ ?

You are not permitted to operate the tension meter before doing so.

Before working with the instrument you must put on your personal protective clothing, if necessary. For example, eye protectors, gloves, etc.

To avoid damage, do not move the center roller by hand.

Tensions that exceed the tension range of the instrument by more than 100% may cause permanent damage to the measuring spring and must be avoided under any circumstances.

#### 3.1.1 ID Plate, CE Mark, Calibration Label

- The ID plate with the CE mark and the serial number as well as the calibration label (optional) are provided on the bottom of the instrument, the SCHMIDT Quality Seal is provided on the left side.

ID plate with CE mark  
and serial number

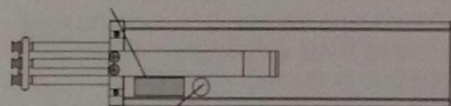

Calibration label  
(option)

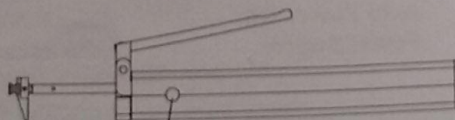

SCHMIDT  
Quality Seal

fig. 3.1.1

### 3.1.2 Removing the Filament Guide

The tension meter is supplied with a FILAMENT GUIDE for fast and easy material acquisition. For application in hard-to-reach areas with limited access space, you can remove the FILAMENT GUIDE.

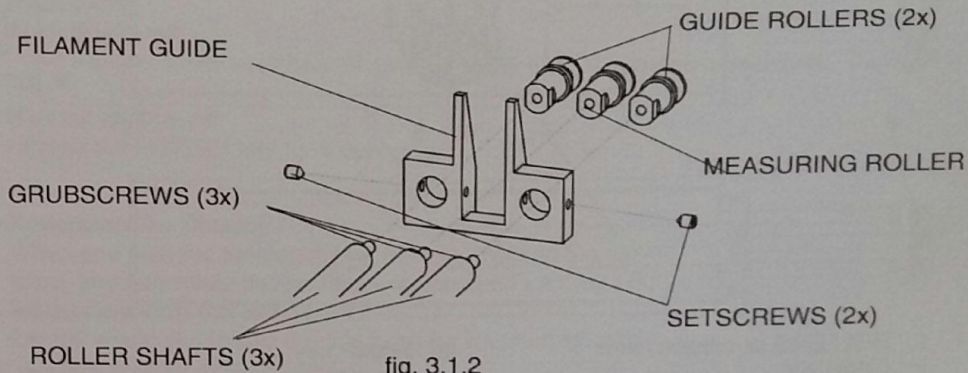

fig. 3.1.2

#### Removal:

- Loosen the SETSCREWS (2x) with the supplied screwdriver (blade width 1.5 mm).
- Unscrew and remove the GUIDE ROLLERS (2x) with the supplied open end wrench (jaw width 4 mm).
- Slip the FILAMENT GUIDE off the ROLLER SHAFTS.
- Screw the GUIDE ROLLERS (2x) back on to the ROLLER SHAFTS and carefully tighten them using the supplied open end wrench (jaw width 4 mm) until hand-tight.

### 3.1.3 Mounting the Filament Guide

- Unscrew and remove the GUIDE ROLLERS (2x) with the supplied open end wrench (jaw width 4 mm).
- Slip the filament guide on to the ROLLER SHAFTS.
- Screw the GUIDE ROLLERS (2x) back on to the ROLLER SHAFTS and carefully tighten them using the supplied open end wrench (jaw width 4 mm) until hand-tight.
- Push the FILAMENT GUIDE forward far enough to ensure that the rollers do not rub against the FILAMENT GUIDE and that the process material can slide unhindered from the FILAMENT GUIDE into the roller grooves (fig. 3.1.3 CENTER LINE).
- Carefully tighten the SETSCREWS (2x) with the supplied screwdriver (blade width 1.5 mm) until hand-tight.

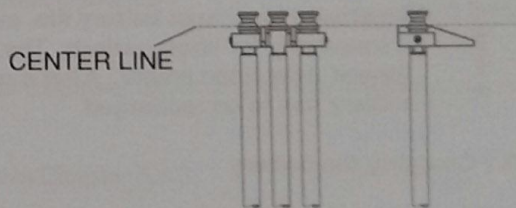
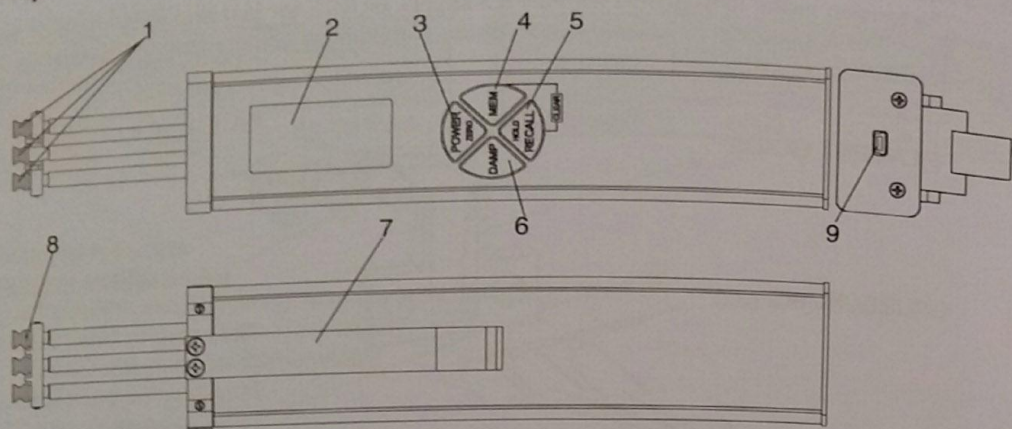

fig. 3.1.3

### 3.2 Operating Elements



- 1 ROLLERS or ceramic pins
- 2 DISPLAY
- 3 POWER / ZERO key
- 4 MEM key
- 5 RECALL / HOLD key

- 6 DAMP key
- 7 LEVER
- 8 FILAMENT GUIDE
- 9 Output for connecting the AC adapter

fig. 3.2

### 3.3 Setup

The tension meter comes with a built-in rechargeable LiPo battery, which has been charged at the factory. The tension meter can only be switched on if the battery is still working, i.e. if the battery has enough charge. If the instrument does not power up or if the battery level indicator shows only one bar  after power-up (Chapter 3.3.2), the battery needs to be recharged.

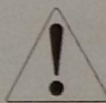

To ensure maximum battery life, avoid discharging it completely or charging it frequently for short periods. The battery should not be stored for a prolonged time when empty. After a maximum storage period of one year, the battery has to be recharged.

#### 3.3.1 Charging the Battery



The battery can only be charged at a temperature between +5 °C and +45 °C. Before you connect the AC adapter, verify that the supplied voltage is correct (100 V - 240 V).

HANS SCHMIDT & Co. GmbH provides no warranty or liability for any damage resulting from the use of AC adapters from other manufacturers.

To charge the battery, connect the cable of the AC adapter to the accordant output (Chapter 3.2).

When the battery is fully charged, the battery level indicator will show 3 bars . The charging time is approx. 3 ½ hours.

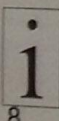

Battery overcharging is not possible



### 3.3.2 Switch-On

Press the POWER key until the DISPLAY momentarily shows the tension range and the software version, e.g. E 1.0, followed by random values or "0."

### 3.3.3 Switch-Off

#### Auto power off:

- The tension meter switches off automatically after 3 minutes of non-use.

#### Manual switch-off:

- Press the POWER key for 5 seconds.

### 3.3.4 Reversing the Display

When you shift the tension meter from the right to the left hand, you can rotate the readings on the DISPLAY by 180°.

#### Measuring with the left hand:

- If you would like to use the left hand for measuring, you should reverse the readings on the DISPLAY to make them easier to read.

#### Requirement:

Tension meter switched off as described in Chapter 3.3.3.

#### To rotate the display by 180°

- Press and hold the DAMP and POWER keys until the DISPLAY shows the readings the other way around.

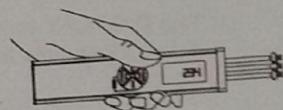

fig. 3.3.4a

#### Measuring with the right hand:

#### Requirement:

Tension meter switched off as described in Chapter 3.3.3.

#### To restore the default orientation:

- Press and hold the DAMP and POWER keys until the DISPLAY shows the readings in the default orientation.

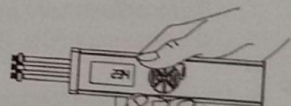

fig. 3.3.4b

### 3.3.5 Selecting the Unit of Measure

You can set the ETB to the cN or g unit of measure, depending on the required tension range. The default setting is cN.

#### Requirement:

Tension meter switched off as described in Chapter 3.3.3.

#### To select the unit of measure:

- Press and hold the RECALL and POWER keys until the new unit of measure

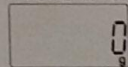

is indicated on the DISPLAY.

### 3.3.6 Zero Adjustment of the Measuring Position (Auto Zero)

Zero adjustment is automatically carried out for the current measuring position.

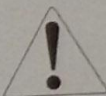

**Zero adjustment must be carried out whenever the tension meter does not display "0" in measuring position.  
The process material must not yet be inserted!**

#### Requirements:

- Tension meter switched on as described in Chapter 3.3.2.
- Unit of measure selected as described in Chapter 3.3.5.

#### To carry out zero adjustment:

- Hold the ETB in the desired measuring position. Be careful to hold the instrument absolutely steady.
- Press the POWER key.

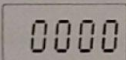
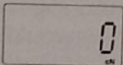
The DISPLAY momentarily shows  and then switches to .  
The ETB is now adjusted for the new material path and is ready to measure.

## 3.4 Operating Procedure

#### Requirements:

- Tension meter switched on (Ch. 3.3.2).
- Unit of measure selected (Ch. 3.3.5)
- Damping factor set, if necessary (Ch. 3.4.1).
- Zero adjustment performed, if necessary (Ch. 3.3.6).

#### To insert the process material:

- Press the LEVER to tilt the outer GUIDE ROLLERS sideways.
- Thread the PROCESS MATERIAL through the MEASURING ROLLERS (FILAMENT GUIDE)
- Slowly release pressure on the LEVER until the GUIDE ROLLERS return to their original position.

It is important to assure that the PROCESS MATERIAL runs smoothly between the MEASURING- and GUIDE ROLLERS

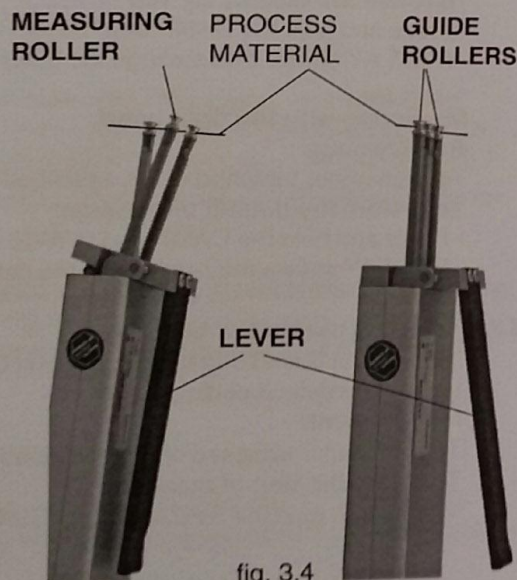

#### To measure the process material:

The DISPLAY now shows the measured tension values.

Error messages which might be displayed are described in Chapter 3.6.

#### To remove the process material:

- Press THE LEVER and remove the PROCESS MATERIAL.
- Slowly release pressure on the LEVER until the GUIDE rollers return to their original position.

### 3.4.1 Switching on Damping Mode

The ETB is equipped with an electronic damping which ensures steady readings when tension fluctuates. This is achieved by averaging the measured values at the set update rate. Before switching on the damping mode, it is recommended that you measure the first values without damping enabled.

#### Requirements:

- Process material inserted as described in Chapter 3.4
- The DISPLAY has shown the first tension values.

#### To switch on damping:

- Press the DAMP key.  
The DISPLAY shows the set damping factor.
- Release the DAMP key.

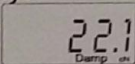
The DISPLAY shows  DAMP below the currently measured value.

#### To switch off damping:

- Press the DAMP key.

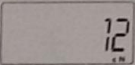
The DISPLAY shows  only the currently measured value.

### 3.4.2 Changing the Damping Factor

The tension meter is factory preset to a damping factor of 12. The tension values are thereby averaged for the display in the following way:

$$\frac{12 \text{ old values} + 4 \text{ new values}}{16}$$

The damping factor can be modified in 15 steps from 01 = low damping:

$$\frac{1 \text{ old value} + 15 \text{ new values}}{16}$$

to 15 = high damping

$$\frac{15 \text{ old values} + 1 \text{ new value}}{16}$$

#### Requirement:

- Tension meter switched on as described in Chapter 3.3.2.

#### To change the damping factor:

- Press and hold the DAMP key.  
The DISPLAY shows the set damping factor.  
You can now increase the damping factor with the MEM key and decrease it with the RECALL key.
- Release the DAMP key.  
The tension meter switches back to measuring mode.

### 3.5 Storing the Tension values

The tension meter features a data logger which stores the following data obtained during a measuring period:

Average value

Last value

Maximum value (MAX),

Minimum value (MIN),

Minimum peak value (MIN PEAK)

Maximum peak value (MAX PEAK)

The measured data remain stored in the ETB memory even after the instrument is switched off.

**1** The stored tension values remain stored in the ETB memory even after the instrument is switched off.

#### Requirements:

- Tension meter switched on as described in Chapter 3.3.2.
- Process material inserted as described in Chapter 3.4.

#### To store the tension values:

- Press the MEM key to start the measuring period.

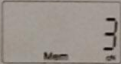
While the tension data are stored, the MEM  indicator blinks on the DISPLAY and the currently measured value is displayed.

- When you want to end the measuring period, press the MEM key once again. Data logging is stopped.

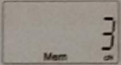
The DISPLAY shows  MEM and the current reading.



### 3.5.1 Recalling the Stored Tension Values

#### Requirement:

- Tension meter switched on as described in Chapter 3.3.2.
- You can end recall any time by pressing the POWER key.

#### To recall the tension values:

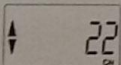

- Press the RECALL key.

The DISPLAY blinks, showing  the average value of the measuring period and the  symbol.

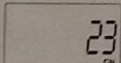

- Press the RECALL key.

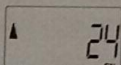
The DISPLAY blinks, showing  the last value of the measuring period.

- Press the RECALL key.

The DISPLAY blinks, showing  the maximum value of the measuring period and the  symbol.

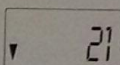
- Press the RECALL key.

The DISPLAY blinks, showing  the minimum value of the measuring period and the  symbol.

- Press the RECALL key.

### 3.5.1 Recalling the Stored Tension Values (Cont.)

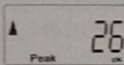
The DISPLAY blinks, showing  the maximum peak value of the measuring period, the PEAK indicator and the ▲ symbol.  
- Press the RECALL key.

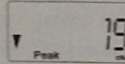
The DISPLAY blinks, showing  the minimum peak value of the measuring period, the PEAK indicator and the ▼ symbol.

- Press the RECALL key.
- The tension meter switches back to measuring mode.

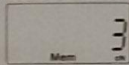
The DISPLAY shows  MEM and the current reading.  
The tension meter is ready for a new measuring period. The previously stored tension values will then be overwritten with new values.

### 3.5.2 Clearing the ETB Memory

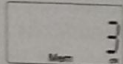
If values are stored in the ETB memory, the DISPLAY shows e.g.  with the MEM indicator.

#### To clear the memory:

- Simultaneously press the MEM and RECALL keys.

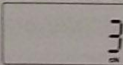
The DISPLAY shows e.g. ; all values stored in the memory have been deleted.

### 3.5.3 Memory Function HOLD

When the tension meter memory is empty, you can retain the last reading on the DISPLAY by using the memory function HOLD.

#### To retain the last reading:

- Press the RECALL / HOLD key once for about 1 second.

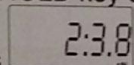
The DISPLAY shows  the last reading and the ":" colon symbol.

#### To switch back to measuring mode:

- Press the RECALL / HOLD key once for about 1 second.
- The tension meter switches back to measuring mode.

### 3.6 Error Messages

#### Error message 1:

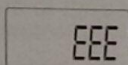
- The DISPLAY shows .
- The upper limit of the tension range was exceeded by more than 10%.  
Reduce the line tension.

OR

AUTO ZERO is no longer possible.

Recalibrate the instrument following the directions in Chapter 3.9.

### 3.6 Error Messages (Cont.)

#### Error message 2:

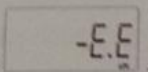

- The DISPLAY shows

The lower limit of the tension range was fallen below by more than 10%.  
Properly insert the process material.

OR

AUTO ZERO is no longer possible.

Recalibrate the instrument following the directions in Chapter 3.9.

### 3.7 Static Verification of Measuring Accuracy

All tension meters are calibrated with standard materials - such as polyamide monofilament (PA) - according to the SCHMIDT factory procedure. The diameters are given in Chapter 2.

Any difference in process material size and rigidity from the standard material may cause a deviation of the accuracy. In 95% of all industrial applications, the SCHMIDT calibration has been proven to provide the best results and is used for comparative purposes.

#### Requirements:

- The ETB is factory calibrated for a vertical material path (fig. 3.7).
- Tension meter switched on as described in Chapter 3.3.2.
- The required reference weight must be provided.

- **1** The tension meter has been calibrated dynamically according to the SCHMIDT factory procedure. Therefore, differences may occur between static and dynamic readings.

#### Verification procedure:

- Hang a weight which corresponds to the tension to be measured (pay attention to the correct unit of measure cN) from the measured material, vertically, as shown in fig. 3.7.
- Press the LEVER down all the way.
- Thread the process material through the MEASURING- and GUIDE ROLLERS as described in Chapter 3.4.
- Slowly release pressure on the LEVER until the GUIDE ROLLERS return to their original position.
- Before starting the calibration, move the instrument slowly up and down to compensate for possible mechanical friction losses and thus ensure repeatability of the measurements.
- The tension value shown on the DISPLAY should be equal to the value of the suspended weight (Pay attention to the measuring units).

If this procedure shows a deviation, you can recalibrate the instrument following the directions in Chapter 3.9.

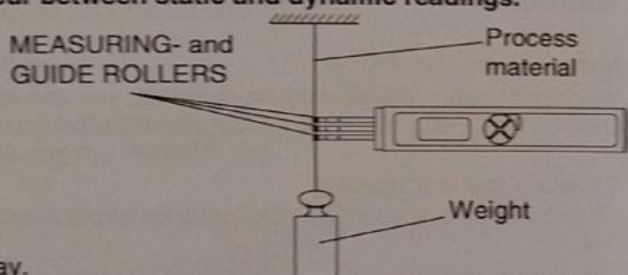

fig. 3.7

### 3.8 Dynamic Calibration of the ETB

All tension meters are calibrated with standard materials - such as polyamide monofilament (PA) - according to the SCHMIDT factory procedure. The diameters are given in Chapter 2.

In 95% of all industrial applications, the SCHMIDT calibration has been proven to provide the best results and is used for comparative purposes.

Fig. 3.8. shows the basic setup of a dynamic calibration.

The procedure for a static calibration using a simpler setup is described in Chapter 3.9.

- 1** The tension meter has been calibrated dynamically according to the SCHMIDT factory procedure. Therefore, differences may occur between static and dynamic readings.

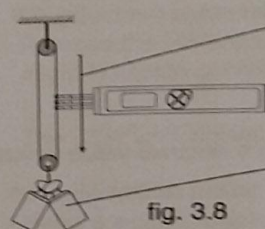

fig. 3.8

### 3.9 Static Calibration of the ETB

#### Requirements for static calibration:

- The ETB is factory calibrated for a vertical material path (fig. 3.7). Recalibration must also be carried out with a vertical material path.
- One cN weight each, corresponding to 10%, 40%, 70 % and 100% of the tension range, must be provided.
- No process material inserted.
- Tension meter switched off.

#### To select the calibration mode:

- Press and hold the MEM and

POWER keys until the DISPLAY shows

- Release first the POWER key and then the MEM key.

#### To calibrate the zero point:

- Press the RECALL key.

As long as the RECALL key is depressed, the DISPLAY shows a random decimal value

between -2000 and 2000, e.g.

This decimal value may vary from instrument to instrument.

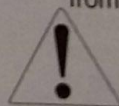

**If the value is outside this range, calibration cannot be guaranteed.**

- Release the RECALL key when the value shown on the DISPLAY is fairly stable (the reading might fluctuate greatly).

The DISPLAY shows

### 3.9 Static Calibration of the ETB (Cont.)

#### 1st calibration point:

- Hang a weight which corresponds to 10% of the tension range from the measured material, vertically, as shown in fig. 3.9
- Press the LEVER down all the way.
- Thread the process material through the MEASURING- and GUIDE ROLLERS as described in Chapter 3.4.
- Slowly release pressure on the LEVER until the GUIDE ROLLER return to their original position.
- Before starting the calibration, move the instrument slowly up and down to compensate for possible mechanical friction losses and thus ensure repeatability of the measurements.

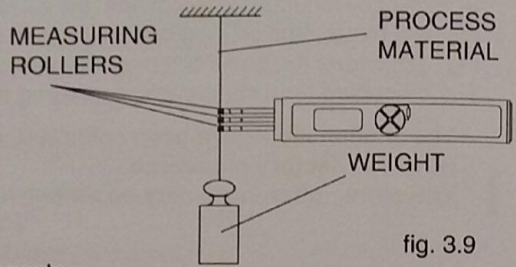
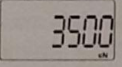

fig. 3.9

#### a) Press the RECALL key.

As long as the RECALL key is depressed, the DISPLAY shows a decimal value which is

higher than the first decimal value, e.g. .

This decimal value may vary from instrument to instrument.

- Release the RECALL key when the value shown on the DISPLAY is stable (the reading might fluctuate greatly).

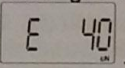
The DISPLAY shows .

#### 2nd calibration point:

- Hang a weight which corresponds to 40% of the tension range from the measured material, vertically, as shown in fig. 3.9.
- Press the LEVER down all the way.
- Thread the process material through the MEASURING- and GUIDE ROLLERS as described in Chapter 3.4.
- Slowly release pressure on the LEVER until the outer rollers return to their original position.
- Before starting the calibration, move the instrument slowly up and down to compensate for possible mechanical friction losses and thus ensure repeatability of the measurements.

#### b) Press the RECALL key.

As long as the RECALL key is depressed, the DISPLAY shows a decimal value which is

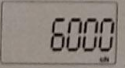
higher than the second decimal value, e.g. .

This decimal value may vary from instrument to instrument.

- Release the RECALL key when the value shown on the DISPLAY is stable (the reading might fluctuate greatly).

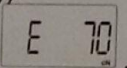
The DISPLAY shows .

#### 3rd calibration point:

- Hang a weight which corresponds to 70% of the tension range from the measured material, vertically, as shown in fig. 3.9
- Press the LEVER down all the way.



### 3.9 Static Calibration of the LTD (Cont.)

- Thread the process material through the MEASURING- and GUIDE ROLLERS as described in Chapter 3.4.
- Slowly release pressure on the LEVER until the outer rollers return to their original position.
- Before starting the calibration, move the instrument slowly up and down to compensate for possible mechanical friction losses and thus ensure repeatability of the measurements.

c) Press the RECALL key.

As long as the RECALL key is depressed, the DISPLAY shows a decimal value which is

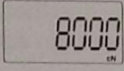
higher than the second decimal value, e.g. .

This decimal value may vary from instrument to instrument.

- Release the RECALL key when the value shown on the DISPLAY is stable (the reading might fluctuate greatly).

The DISPLAY shows

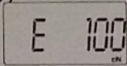

#### 4th calibration point:

- Hang a weight which corresponds to 100% of the tension range from the measured material, vertically, as shown in fig. 3.9
- Press the LEVER down all the way.
- Thread the process material through the MEASURING- and GUIDE ROLLERS as described in Chapter 3.4.
- Slowly release pressure on the LEVER until the GUIDE ROLLERS return to their original position.
- Before starting the calibration, move the instrument slowly up and down to compensate for possible mechanical friction losses and thus ensure the repeatability of the measurements.

d) Press the RECALL key.

As long as the RECALL key is depressed, the DISPLAY shows a decimal value which is

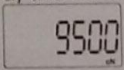
higher than the third decimal value, e.g. .

This decimal value may vary from instrument to instrument.

- Release the RECALL key when the value shown on the DISPLAY is stable (the reading might fluctuate greatly).

e) Press the RECALL key.

- Release the RECALL key.

The DISPLAY switches off after approx. 1 sec.

The new calibration has been stored.

- Press the POWER key.

The instrument switches off.

Verify the new calibration, following the directions in Chapter 3.7.

If this procedure shows a deviation, you can recalibrate the tension meter again or restore the factory calibration as described in Chapter 3.9.1.

If the verification of the calibration according to Chapter 3.7 shows a deviation beyond the allowable tolerance and a reliable operation is no longer allowed, the instrument has to be returned to **Hans Schmidt & Co GmbH** for factory recalibration. Please follow the shipping instructions given in Chapter 8.

### 3.9.1 Restoring the Factory Calibration

You can restore the factory calibration any time with the following procedure:

#### Requirement:

- Tension meter switched off.

#### To restore factory calibration:

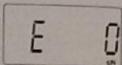
- Press and hold the MEM and POWER keys until the DISPLAY shows .
- Release first the POWER key and then the MEM key.
- Press and hold the DAMP key, then additionally press and hold MEM

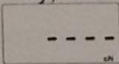
until the DISPLAY shows .

The factory calibration is restored.

- Release the DAMP and MEM key.

The instrument switches off automatically.

## 4 Service and Maintenance

The tension meter is easy to maintain. Depending on operating time and load, the tension meter should be checked according to the locally valid regulations and conditions (as described in Chapter 3.7). The use of other test methods than the procedure described in Chapter 3.7 may cause deviating measuring results.

### 4.1 Rollers

You should regularly inspect the rollers to assure that they are running easily and smoothly. You can replace the rollers yourself, as necessary, by following the directions in Chapter 4.2. Please indicate the tension meter model and the serial number (given on the rear side of the tension meter) in your spare-parts order.

1.) Model ID

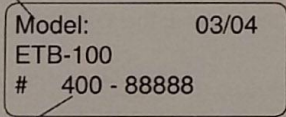

Model: 03/04  
ETB-100  
# 400 - 88888

2.) Serial number

For example:

#### To order spare rollers:

Model: ETB-100 (given on rear side of tension meter)  
Serial number: 400 - 88888 (given on rear side of tension meter)

#### Standard rollers:

Model number: R550217  
Delivery: 1 set (3 pcs.) of spare rollers 2000 m/min

#### To order ceramic pins:

Model: ETPB-100 (given on rear side of tension meter)  
Serial number: 400 - 88888 (given on rear side of tension meter)

#### Ceramic pins:

Model number: R550320  
Delivery: 1 set (3 pcs.) of spare ceramic pins 6000 m/min

## 4.2 Replacing the Rollers/Ceramic Pins

Replacing rollers by ceramic pins or ceramic pins by rollers can only be performed at the manufacturer's facility.



Required tools:

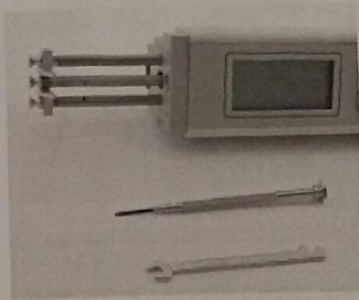

fig. 4.2a

Screwdriver with 1.5 mm blade width  
Open end wrench with 4 mm jaw width

To remove the filament guide:

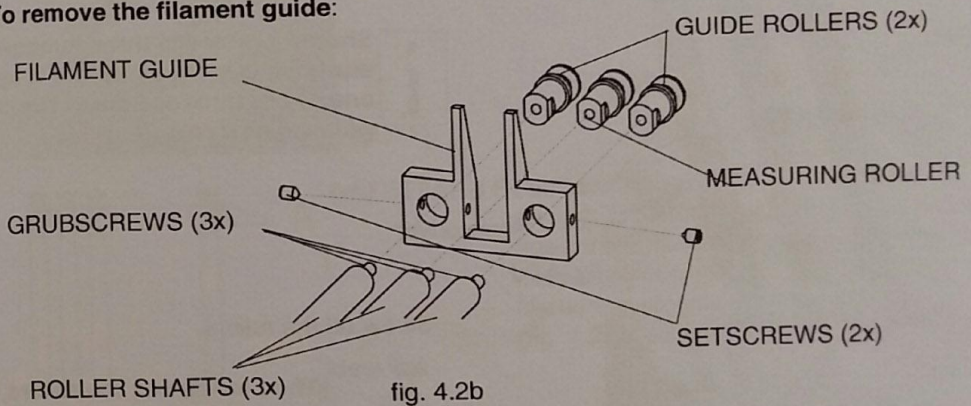

fig. 4.2b

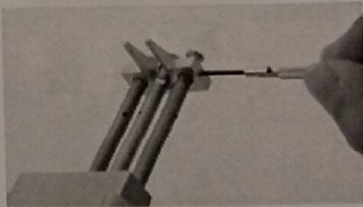

fig. 4.2c

- Loosen the setscrews (2x) with the supplied screwdriver (1.5 mm blade width).

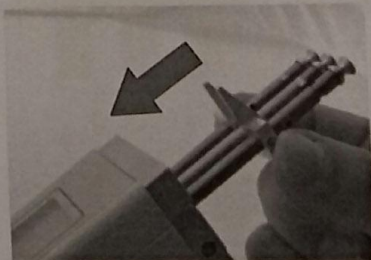
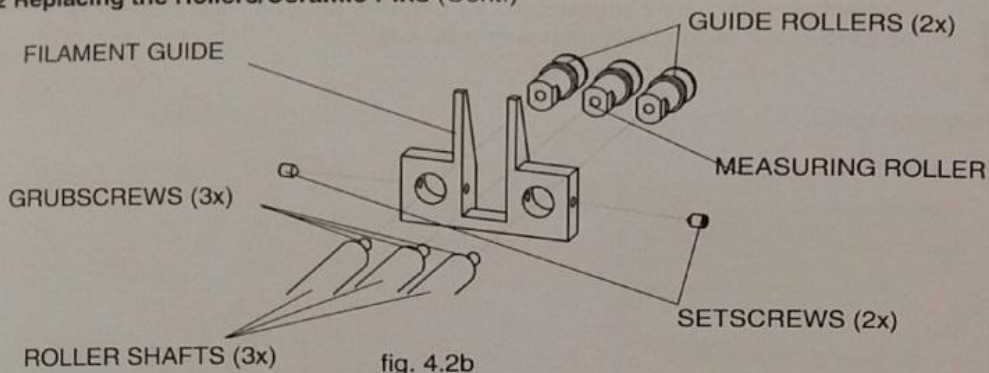

fig. 4.2d

- Slide the filament guide down the roller shafts in the direction of the arrow.

## 4.2 Replacing the Rollers/Ceramic Pins (Cont.)



### To remove the used rollers:

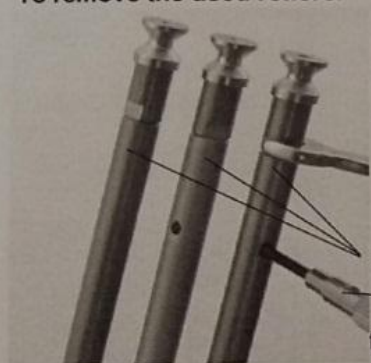

- Loosen the rollers with the supplied open end wrench (4 mm jaw width).

**i** Should any of the three threaded studs be damaged, replace it by one of the threaded studs supplied with the new rollers.

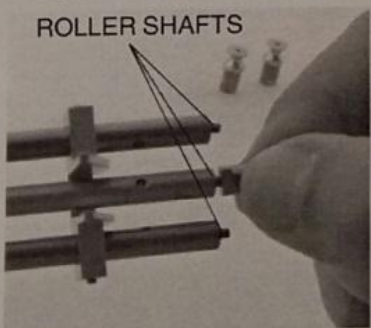

- Screw off the rollers.

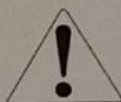

**When loosening the rollers, steady the roller bolts with the supplied screwdriver to prevent loosening of the roller shafts.**

### To mount the new rollers:

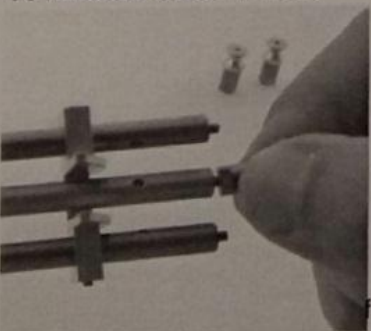

- Screw the new rollers to the roller shafts.

## 4.2 Replacing the Rollers/Ceramic Pins (Cont.)

- Carefully tighten the new rollers with the supplied open end wrench (4 mm jaw width) until hand-tight.



ROLLER SHAFTS (3x)

Screwdriver

fig. 4.2g

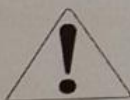

**When tighten the rollers, steady the roller bolts with the supplied screwdriver to prevent the roller bolts from being twisted off.**

To mount the filament guide:

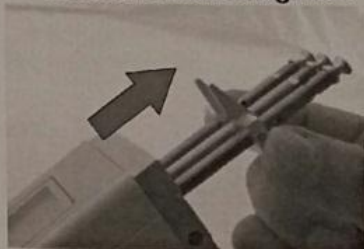

fig. 4.2j

- Slide the filament guide up the roller shafts in the direction of the arrow.

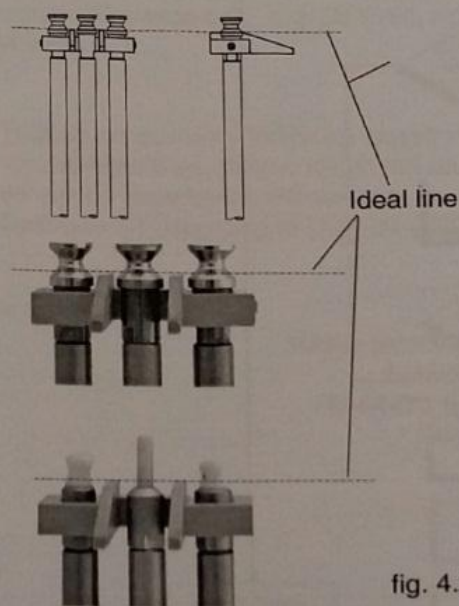

fig. 4.2k

- Push the filament guide upwards far enough to ensure that the rollers do not rub against the filament guide and that the process material can slide unhindered from the filament guide into the roller grooves (fig. 4.2k ideal line).

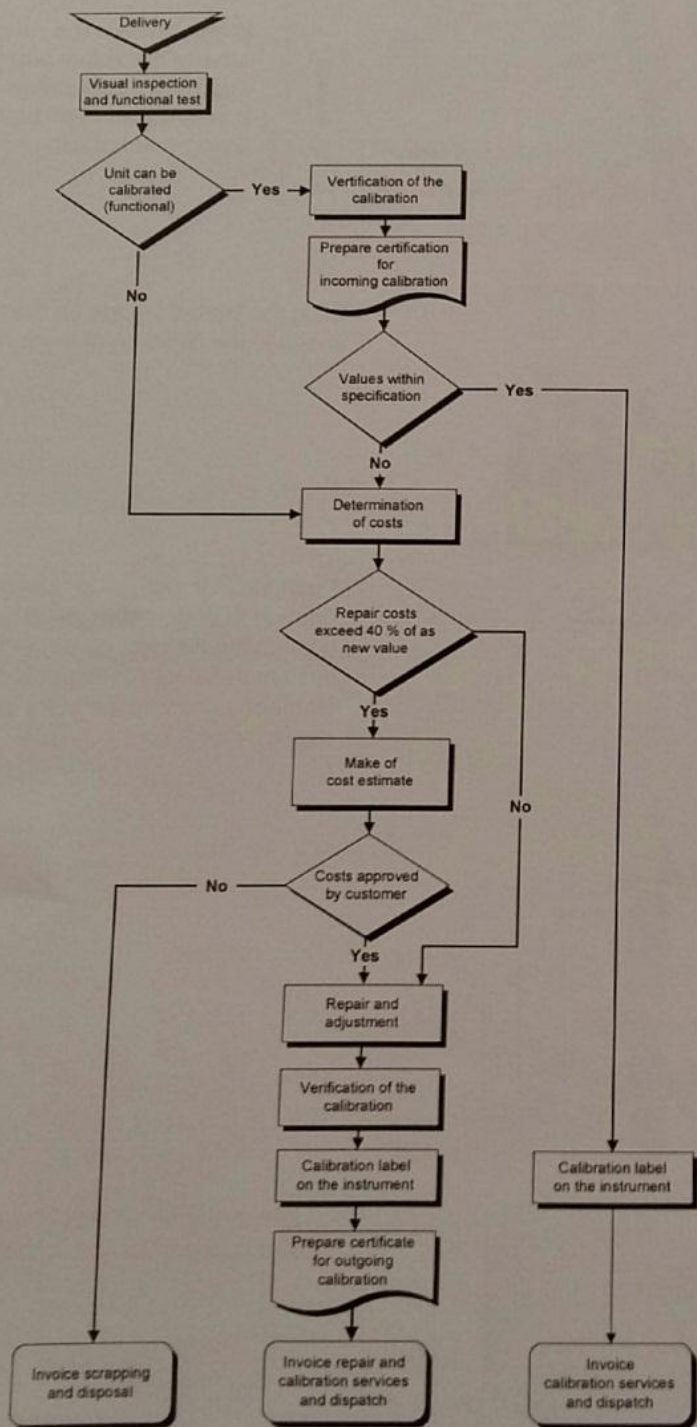

fig. 4.2l

- Tighten the setscrews (2x) with the supplied screwdriver (1.5 mm blade width).

## 5 Verification of Calibration and Determination of Repair Costs

Flow chart for verifying the calibration of used tension meters, incoming and outgoing verification with Inspection Certificate 3.1 according to DIN EN 10204



## 6 Cleaning

For cleaning the unit, do not use any

### **i** AGGRESSIVE SOLVENTS

such as trichloroethylene or similar chemicals.

### **i** NO WARRANTY OR LIABILITY

shall be accepted for damage resulting from improper cleaning.

## 7 Correspondence

Should you have any questions regarding the tension meter or Operating Instructions, or their use, please indicate above all the following details which are given on the ID plate:

- 1) The tension meter model
- 2) The serial number

## 8 Repairs

Shipping instructions:

We kindly ask for return free of charge for us, if possible by airmail parcel. All occurring charges, if any (such as freight, customs clearance, duty, etc.) will be billed to customer. For return from foreign countries, we ask you to include a proforma invoice with a low value for customs clearance only, e.g. 50 Euro, each and to advise the shipment in advance by fax or eMail.

**i** To avoid unnecessary follow-up questions, and the resulting loss of time or possible misunderstandings, please return the tension meter with a detailed fault description to our service department. Please indicate in your order whether you require an Inspection Certificate 3.1 according to DIN EN 10204.

## Service address:

**HANS SCHMIDT & Co GmbH  
Schichtstr. 16  
D-84478 Waldkraiburg  
Germany**

**SCHMIDT-Test-Instruments**  
*indispensable in production monitoring,  
quality control and automation*  
**We solve your measuring problems:**



Tension Meter



Force Gauge



Torque Meter



Tachometer



Speed- and Lengthmeter



Electronic Lengthmeter



Stroboscope



Screen Printing Tension Meter



Thickness Gauge



Yarn Package Durometer and Shore-A Durometer



Sample Cutter



Balance



Moisture Meter



Leak Tester



Softometer

**More than 60 years - Worldwide -**

**Hans Schmidt & Co GmbH**

**Mailing address:**

P. O. B. 1154

D -84464 Waldkraiburg Germany

**Shipping address:**

Schichtstr. 16

D -84478 Waldkraiburg Germany

**Phone:**

int. + 49 / (0)8638 / 9410-0

**Fax:**

int. + 49 / (0)8638 / 4825

int. + 49 / (0)8638 / 67898

**e-mail:**

info@hans-schmidt.com

**Internet:**

<http://www.hans-schmidt.com>